



CDA & TDA

DIODE ASSEMBLIES

- Simple Installation
- Low Cost
- RoHS Compliant (Directive 2002/95/EC)

CDA — CONTROL DIODE ASSEMBLY

The Control Diode Assemblies are designed to supply diode isolation in control circuits. The CDA is molded of rugged glass-coupled acetal copolymer having high dielectric strength and rigid terminal studs for ease in mounting and connection. The CDA is available in single, dual and triple diode packages.

TDA — TRIPPING DIODE ASSEMBLY

The Tripping Diode Assemblies are designed for rectifier isolation to trip more than one device. The line of TDAs include single and dual diode packages. The 910A011 and 910A012 feature surge suppression protection to the diode. Like the CDA, the TDA is molded of rugged glass-coupled acetal copolymer. Installation is easy and cost-effective.

ORDERING INFORMATION

Part Number	Type	Configuration	Average Rectified Forward Current	Peak Non-Replicative Forward Current	Reverse Voltage	Reverse Leakage Current
911A001	CDA	Single Diode	3 A	100 A	800 V	10 μ A
911A002	CDA	Dual Diode	3 A	100 A	800 V	10 μ A
911A003	CDA	Triple Diode	3 A	100 A	800 V	10 μ A
910A001	TDA	Single Diode	12 A	300 A	800 V	10 μ A
910A002	TDA	Dual Diode	12 A	300 A	800 V	10 μ A
910A009	TDA	Single Diode	16 A	310 A	1200 V	10 μ A
910A010	TDA	Dual Diode	16 A	310 A	1200 V	10 μ A
910A011	TDA	Single Diode w/Surge Protection	12 A	300 A	800 V	10 μ A
910A012	TDA	Dual Diode w/Surge Protection	12 A	300 A	800 V	10 μ A

632A050 DIN Rail Mounting Kit 1 kit per unit required

DIMENSIONS

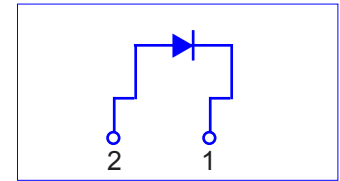
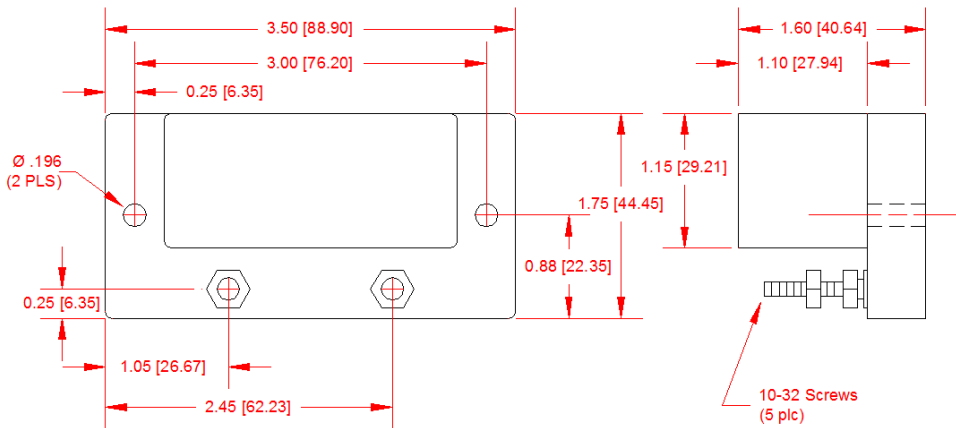

Schematic for CDA, TDA

SINGLE DIODE ASSEMBLY

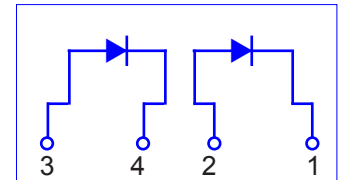
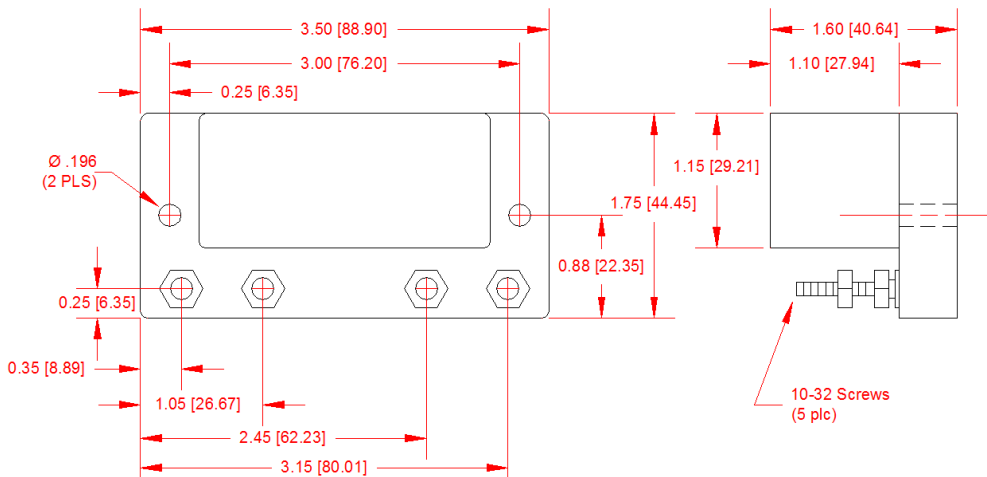

Schematic - CDA

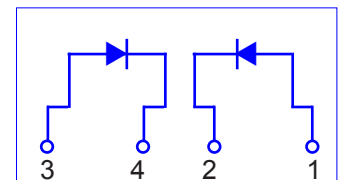

Schematic - TDA

DUAL DIODE ASSEMBLY

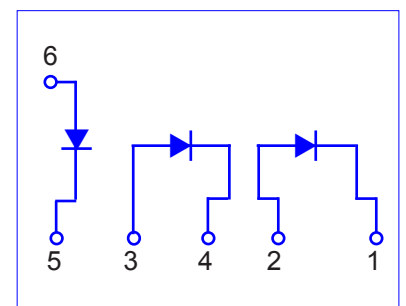
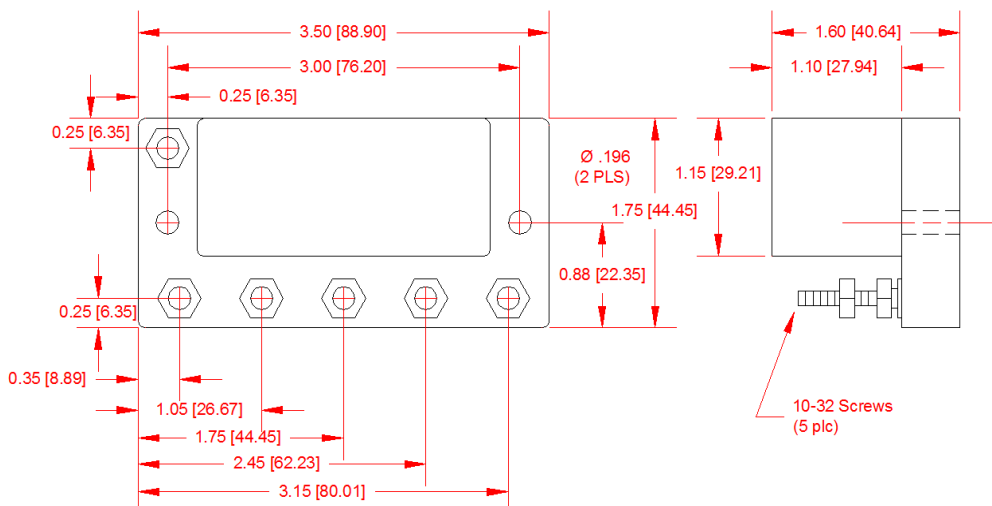

Schematic - CDA

TRIPLE DIODE ASSEMBLY (CDA ONLY)